



MAXI ROYAL - MAXI PLUS - MAXI EMPIRE - MAXIMAJESTIC - MAXI RIVIERA

Genel Teknik Katalog

Bölüm:1



MAXI ROYAL

ASAŞPEN[®]
PVC-U Pencere Sistemleri

MAXI ROYAL SYSTEM

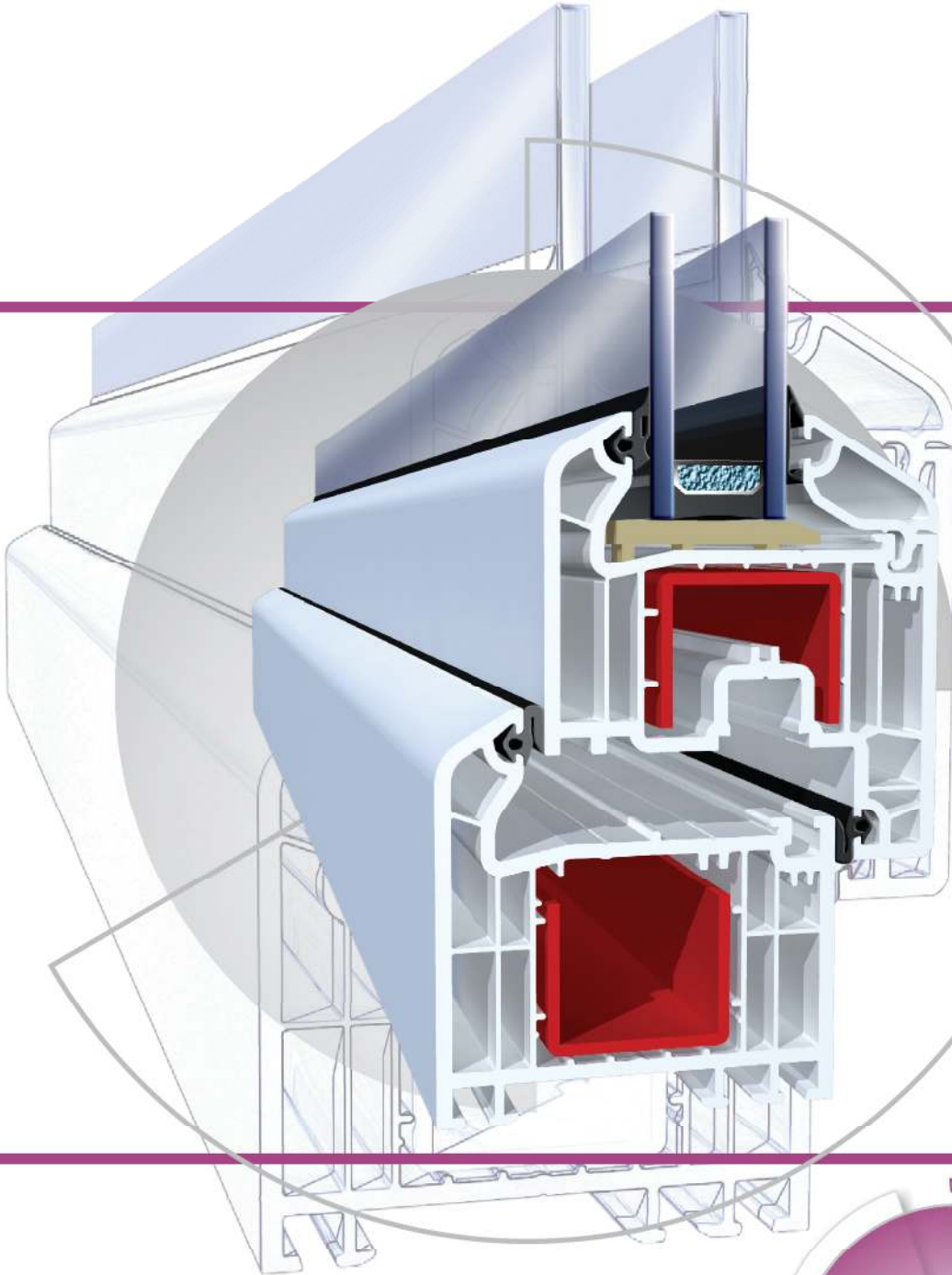

PROFİL TEKNİK ÇİZİMLERİ

KASA PROFİLİ

7051	1.287 kg/m
7051 EU-B	1.159 kg/m

	KALINLIK	AĞIRLIK-kg/m
U - Destek sacı		
DS 01044	1.25mm	0.670
32x20	1.55mm	0.826
	2.05mm	1.078
Kutu Destek sacı		
DS 01044-K	1.25mm	0.972
32x20	1.55mm	1.072
	2.05mm	1.382
U - Destek sacı "İng. sist."		
DS 01043 - 34x6	1.25mm	0.415
	1.55mm	0.509

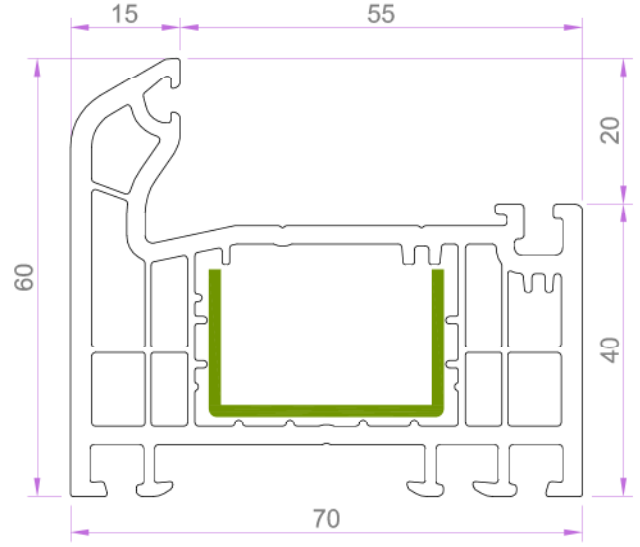

KASA PROFİLİ

7052	1.423 kg/m
7052 EU-B	1.284 kg/m

	KALINLIK	AĞIRLIK-kg/m
U - Destek sacı		
DS 01050	1.25mm	0.833
32 X 30	1.55mm	1.035
	2.05mm	1.368
Kutu Destek sacı		
DS 01050-K	1.25mm	1.148
32 X 30	1.55mm	1.402
	2.05mm	1.829
Alternatif		
U - Destek sacı		
DS 01045	1.25mm	0.788
32 X 26	1.55mm	0.972
	2.05mm	1.243

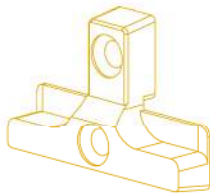
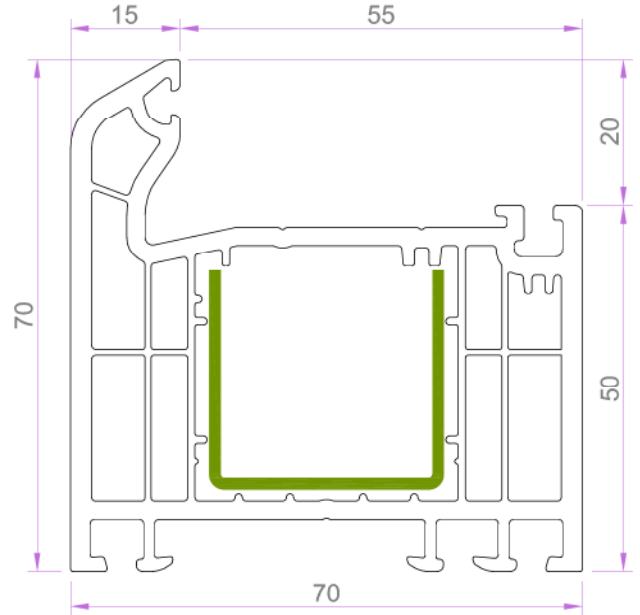

İK01010

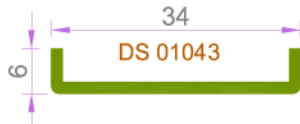

DS 01043

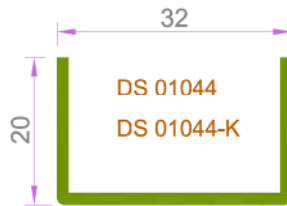
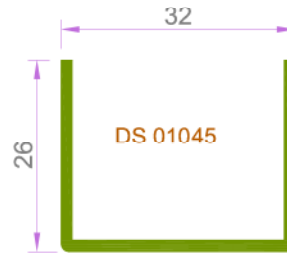
DS 01044
DS 01044-K

DS 01045

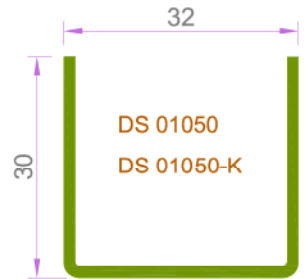
DS 01050
DS 01050-K

PROFİL TEKNİK ÇİZİMLERİ

60 lık PERVAZLI KASA

7068	1.838 kg/m
7068 EU-B	1.649 kg/m

	KALINLIK	AĞIRLIK-kg/m
U - Destek sacı		
DS 01044	1.25mm	0.670
32x20	1.55mm	0.826
	2.05mm	1.078
Kutu Destek sacı		
DS 01044-K	1.25mm	0.972
32x20	1.55mm	1.072
	2.05mm	1.382

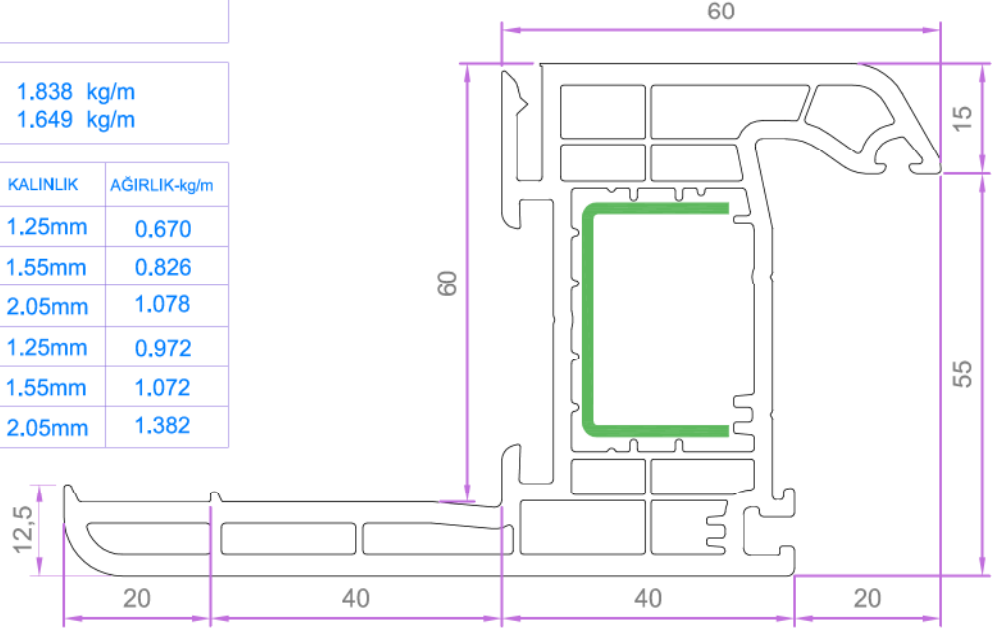

40 lık PERVAZLI KASA

7082	1.469 kg/m
7082 EU-B	1.282 kg/m

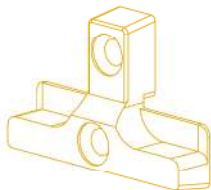
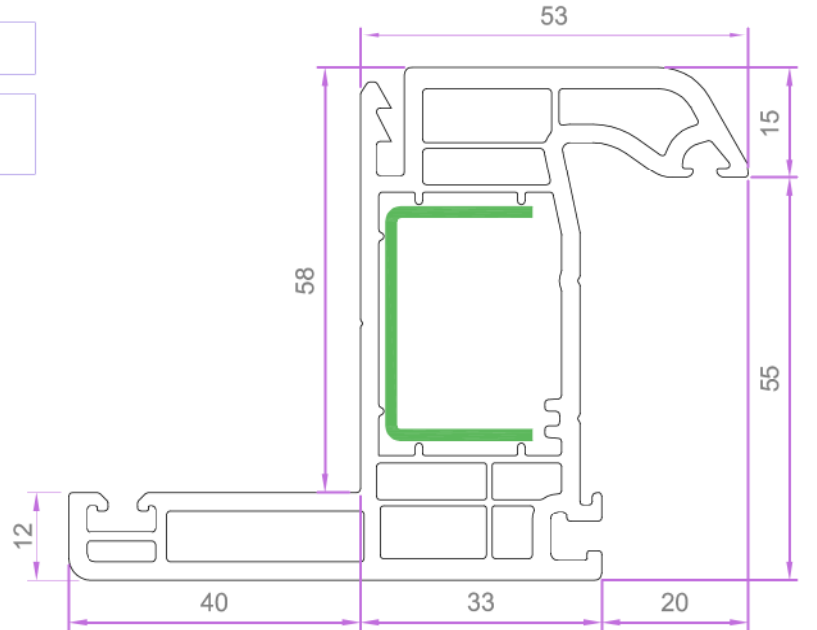

IK01010



DS 01044



DS 01044-K

PROFİL TEKNİK ÇİZİMLERİ

KANAT PROFİLİ

7053	1.446 kg/m
7053 EU-B	1.286 kg/m

	KALINLIK	AĞIRLIK-kg/m
U - Destek sacı	1.25mm	0.788
DS 01045	1.55mm	0.972
32 X 26	2.05mm	1.243

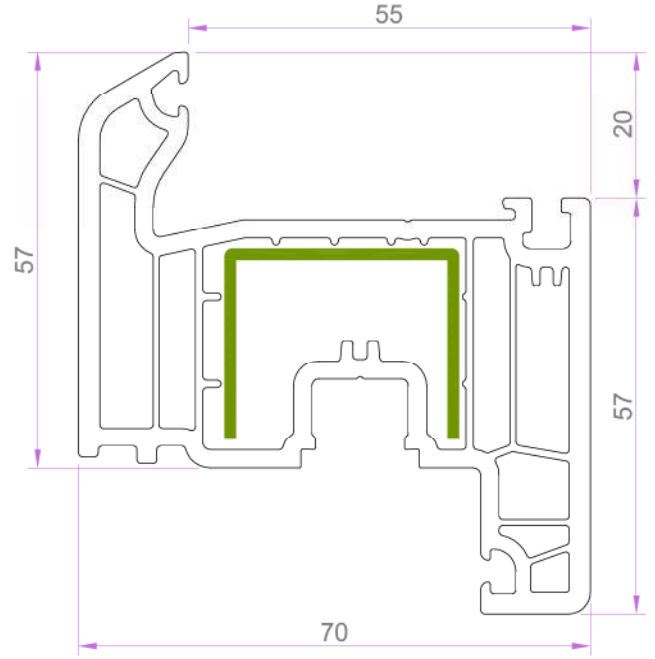

DAMLALIKLI KANAT "6 ODACIKLI"

7054	1.528 kg/m
7054 EU-B	1.362 kg/m

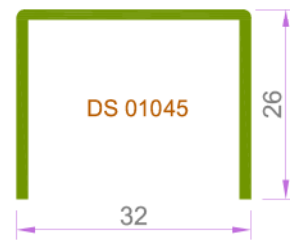
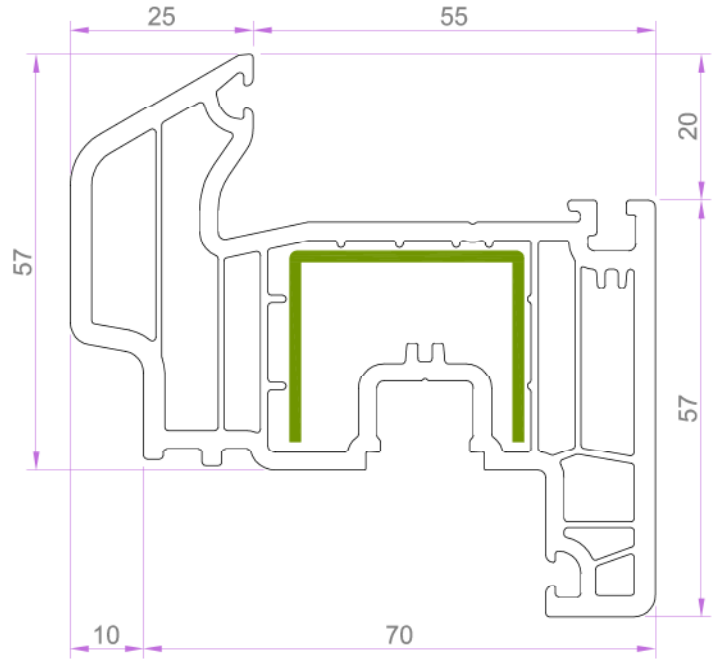

FRANSIZ DAMLALIKLI KANAT

7065

1.259 kg/m

	KALINLIK	AĞIRLIK-kg/m
Destek sacı	1.25mm	0.548
DS 01053	1.55mm	0.678
	2.05mm	0.878

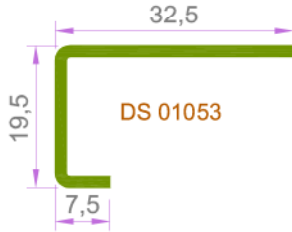
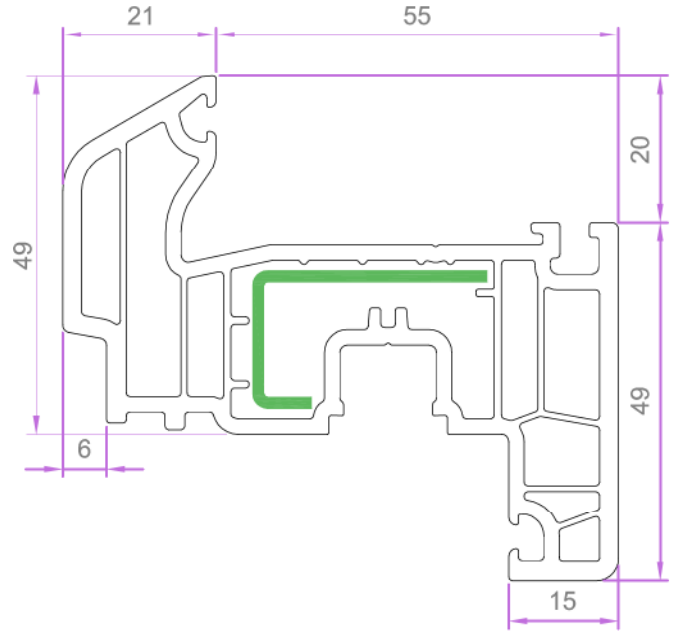

FRANSIZ ADAPTÖR KANAT

7070

1.024 kg/m

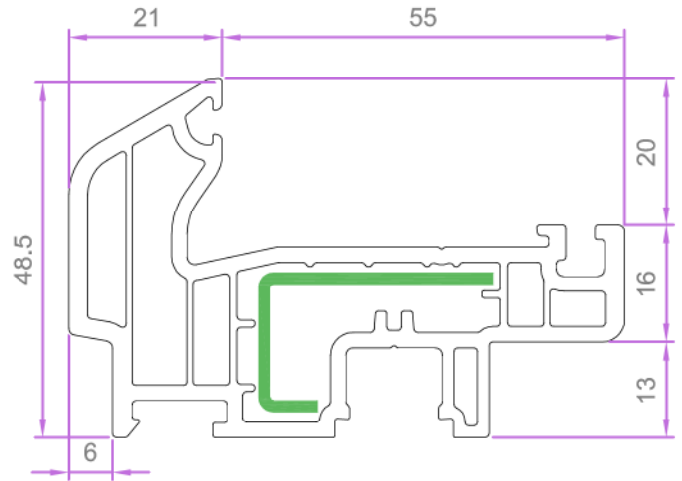

HK01001

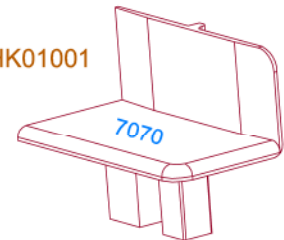

PROFİL TEKNİK ÇİZİMLERİ

7059 HAREKETLİ ORTA KAYIT

7059

1.088 kg/m

	KALINLIK	AĞIRLIK-kg/m
U - Destek sacı	1.25mm	0.788
DS 01045	1.55mm	0.972
32 X 26	2.05mm	1.243

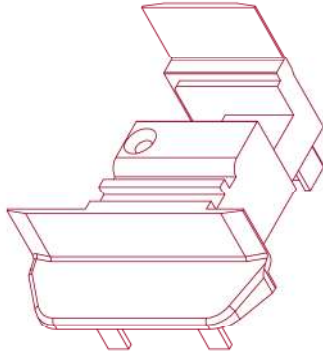

HK01010

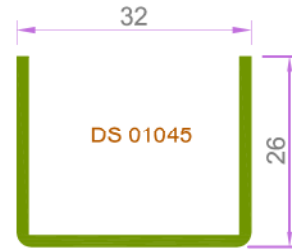
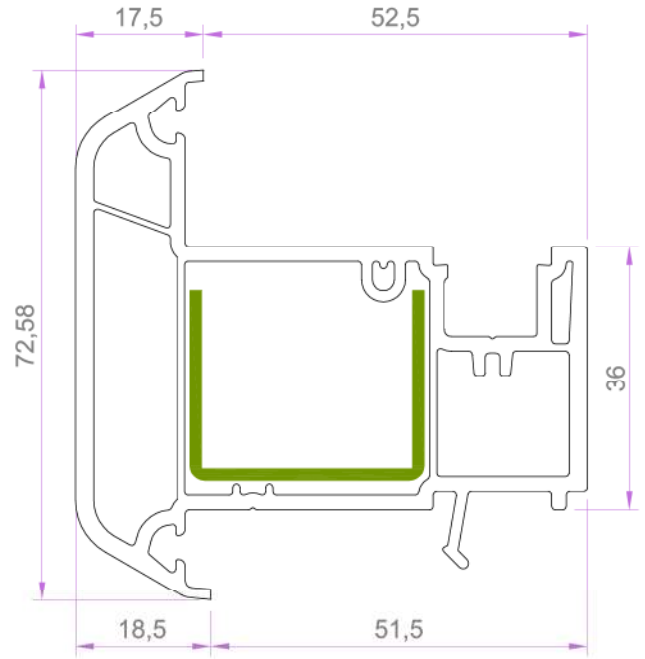

PROFİL TEKNİK ÇİZİMLERİ

ORTA KAYIT PROFİLİ

7055	1.282 kg/m
7055 EU-B	1.143 kg/m

	KALINLIK	AĞIRLIK-kg/m
U - Destek sacı	1.25mm	0.845
DS 01046-K	1.55mm	1.036
35 X 12	2.05mm	1.345

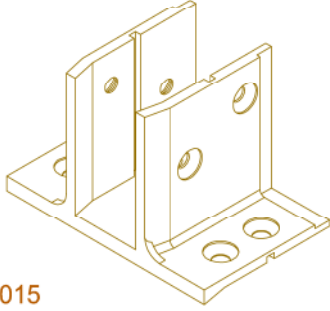

OB01015

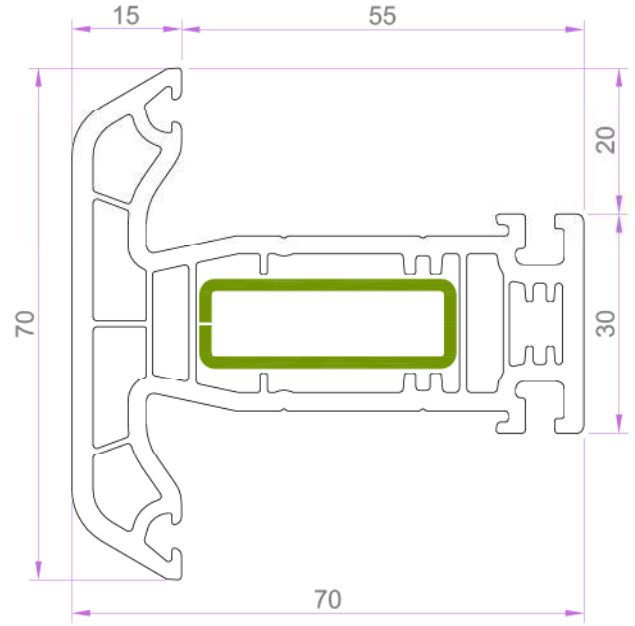

ORTA KAYIT PROFİLİ

7056	1.413 kg/m
7056 EU-B	1.268 kg/m

	KALINLIK	AĞIRLIK-kg/m
U - Destek sacı	1.25mm	0.827
DS 01047	1.55mm	1.035
22 X 35	2.05mm	1.384
Kutu Destek sacı	1.25mm	1.001
DS 01047-K	1.55mm	1.240
35 X 22	2.05mm	1.629

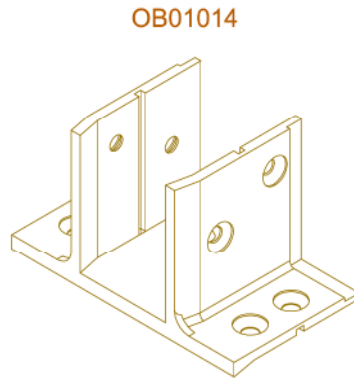

OB01014

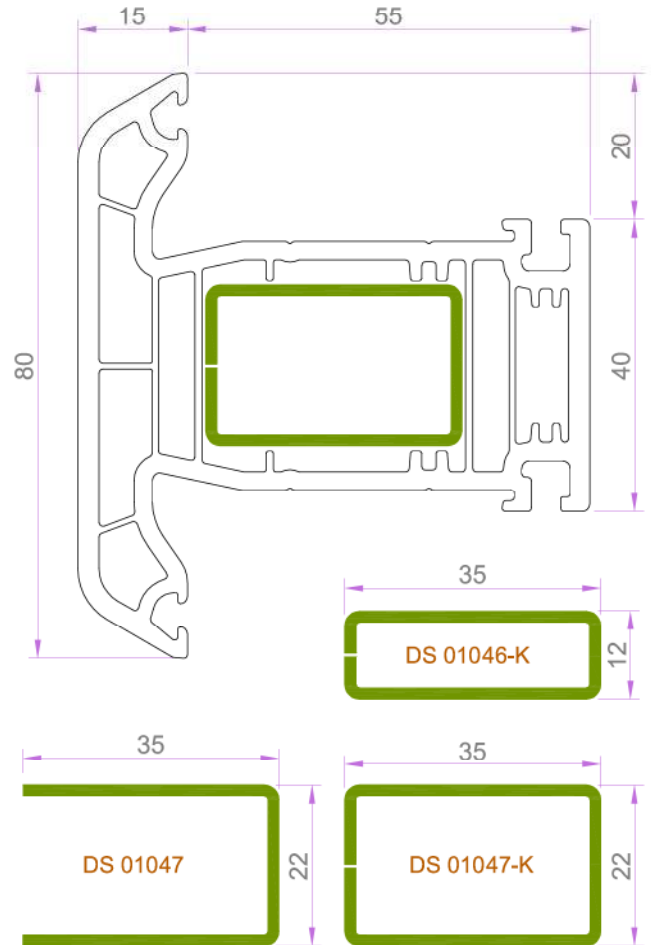

PROFİL TEKNİK ÇİZİMLERİ

ÇEKTİRME VİDALI O.KAYIT (GENİŞ)

7077	1.521 kg/m
7077 EU-B	1.351 kg/m

	KALINLIK	AĞIRLIK-kg/m
U - Destek sacı DS 01062 30 X 40	1.25mm	1.055
	1.55mm	1.297
	2.05mm	1.696
Kutu Destek sacı DS 01048-K 30x40	1.25mm	1.317
	1.55mm	1.612
	2.05mm	2.093

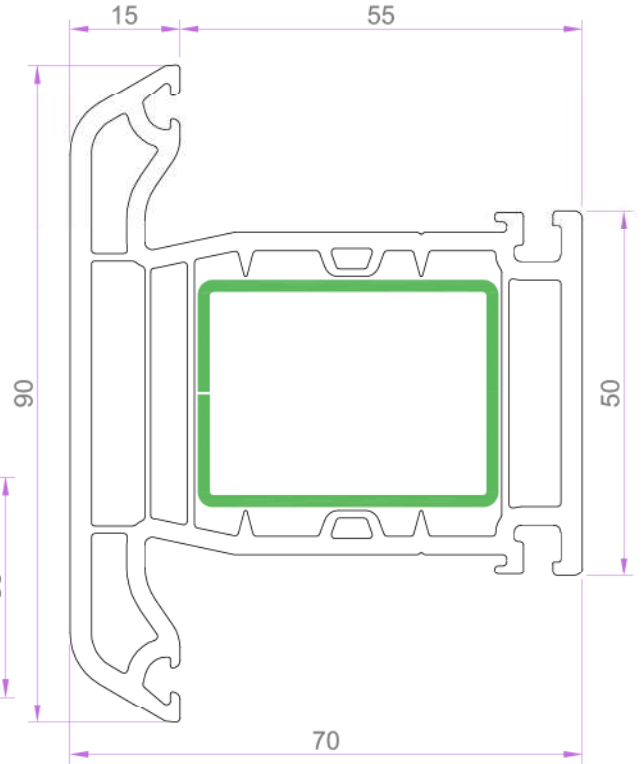
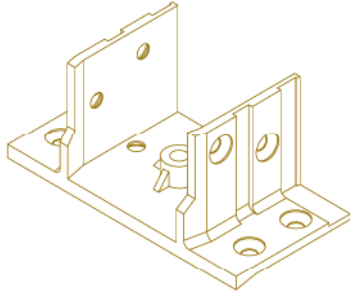
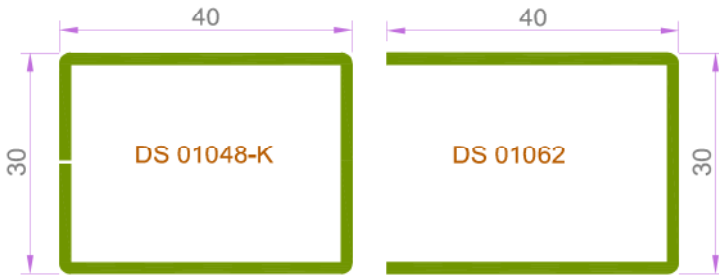

ÇEKTİRME VİDALI O.KAYIT (DAR)

7078	1.302 kg/m
7078 EU-B	1.137 kg/m

	KALINLIK	AĞIRLIK-kg/m
U - Destek sacı DS 01063 11 X 34,5 mm	1.25mm	0.760
	1.55mm	0.931
	2.05mm	1.212
Kutu Destek sacı DS 01063-K 11 x 34,5 mm	1.25mm	0.835
	1.55mm	1.014
	2.05mm	1.302

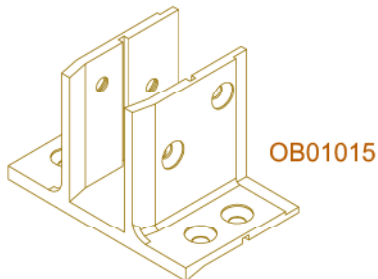

OB01019

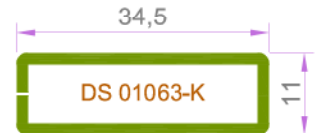
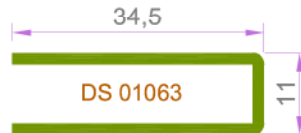
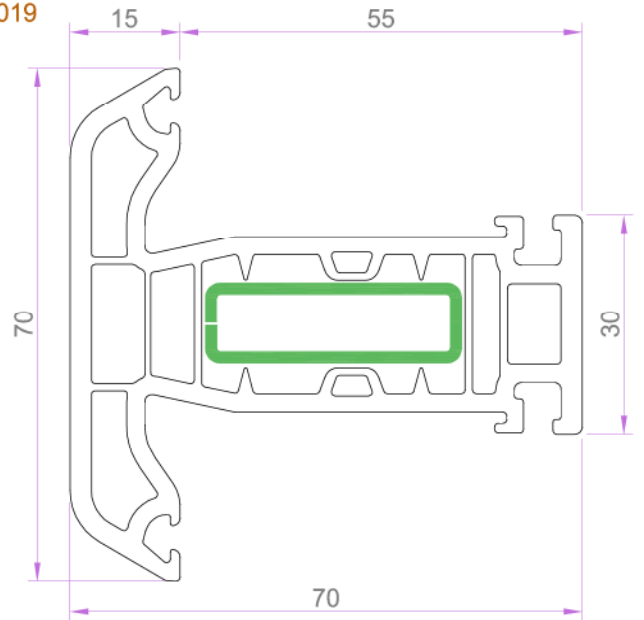

KAPI KANAT PROFİLİ "İÇERİ AÇILAN "

7057	1.953 kg/m
7057 EU-B	1.761 kg/m

	KALINLIK	AĞIRLIK-kg/m
U - Destek sacı	1.25mm	1.184
DS 01048	1.55mm	1.456
30x43x6	2.05mm	1.857
Kutu Destek sacı	1.25mm	1.317
DS 01048-K	1.55mm	1.612
30x40.5	2.05mm	2.093

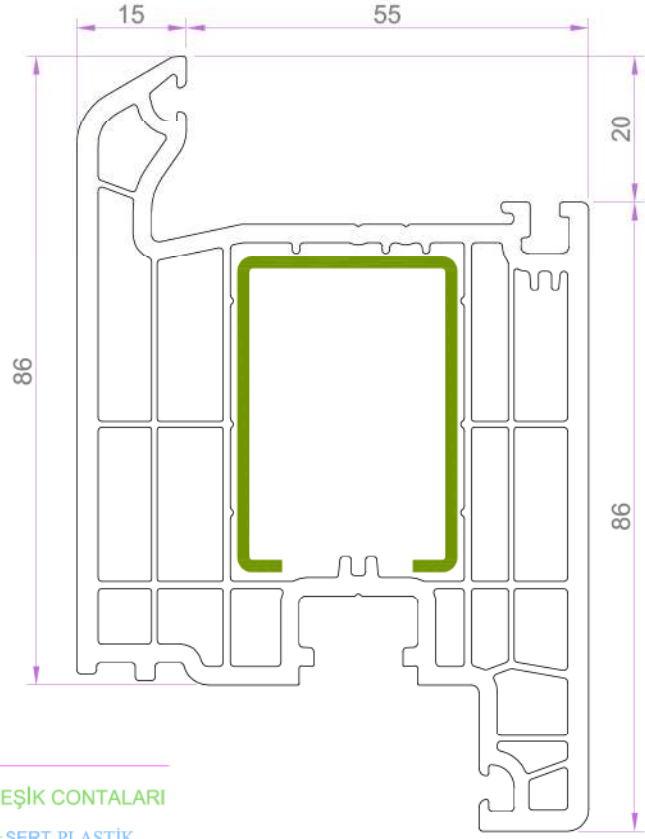

KAPI KANAT ALM. DAMLALIK

05DA01209 - FLOKSAL
 05DA01213 - RAL 9016
 05DA01214 - KOYU KAHVE



ALÜM. DAMLALIK KAPAĞI

05DA01217 -KAP. BEYAZ
 05DA01218 -KAP. GRİ
 05DA01219 -KAP. K.KAHVE

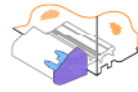

70mm ISI YALITIMLI ALÜM. EŞİK

PLASTİK RENKLİ KAPAK
 ELOKS. ALÜMİNYUM

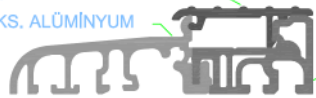

05DA01207 - EŞİK SİYAH KAPAKLI
 05DA01208 - EŞİK GRİ KAPAKLI
 05DA01211 - EŞİK BEYAZ KAPAKLI

ISI YALITIMLI ALÜMİNYUM. EŞİK

(İSPANYOLET KARŞILIK YUVALI)
 05DA01220 - EŞİK GRİ KAPAKLI
 05DA01222 MANTARBAŞLI KARŞILIK

7397 ELOKSAL ALÜMİNYUM EŞİK



AB01015-E ELOKSAL ALM. EŞİK
 AB01015-R SİYAH ELOKSAL ALM. EŞİK

KAPI ALTI EŞİK CONTALARI

SERT PLASTİK
 05DA01210 - 16/12mm
 05DA01215 - 16/10mm
 CONTA



05DA01216-16mm
 SERT PLASTİK
 CONTA



YAN KAPAK

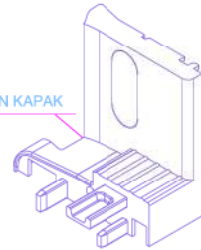

EŞİK PRF. YAN KAPAK (SAĞ&SOL)
 EK01005-7051&7052-L&R-BEYAZ
 EK01005R-7051&7052-L&R-RENKLİ

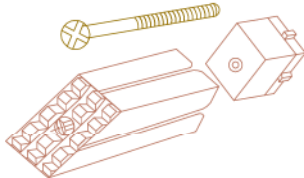
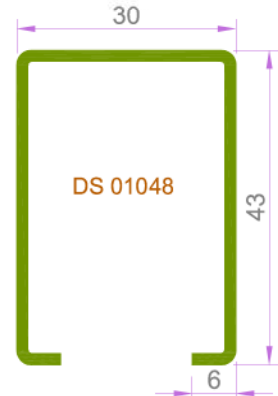
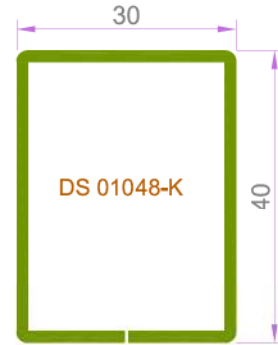

KAPI KÖŞE TAKOZLARI
 KT01004-26x39 DS01048
 KT01005-26x36 DS01048-K

PROFİL TEKNİK ÇİZİMLERİ

KAPI KANAT PROFİLİ "DIŞARI AÇILAN "

7058	1.933 kg/m
7058 EU-B	1.745 kg/m

	KALINLIK	AĞIRLIK-kg/m
U - Destek sacı	1.25mm	1.184
DS 01048	1.55mm	1.596
30x43x6	2.05mm	1.857
Kutu Destek sacı	1.25mm	1.317
DS 01048-K	1.55mm	1.612
30x40	2.05mm	2.093

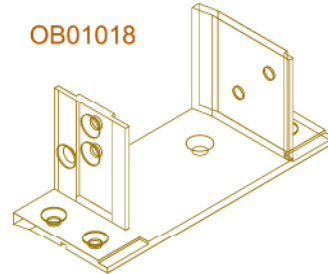
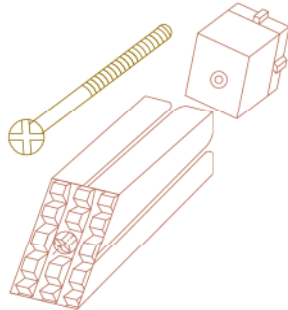
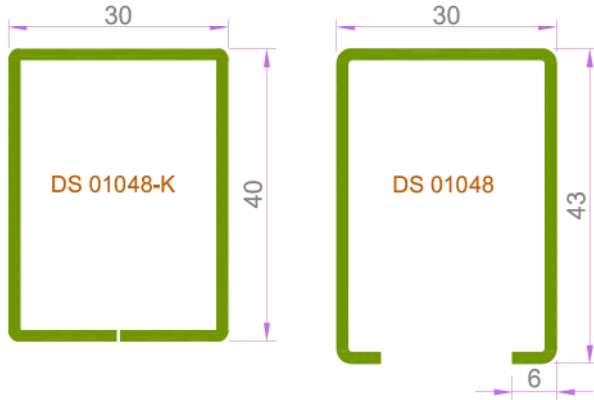
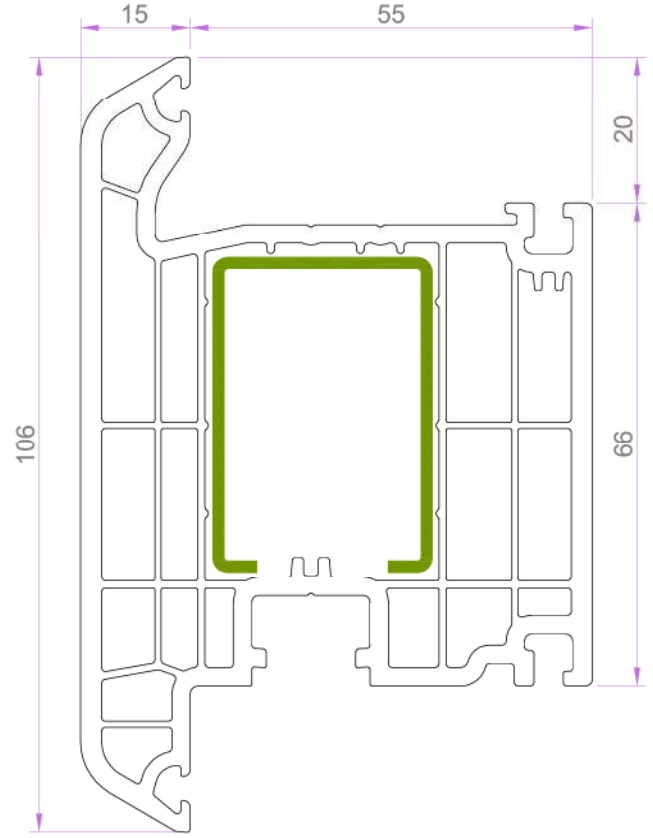

KT01004-26x39 DS01048
KT01005-26x36 DS01048-K

PROFİL TEKNİK ÇİZİMLERİ

FRANSIZ DAMLALIKLI KAPI KANAT

7080	1.775 kg/m
7080 EU-B	1.590 kg/m

	KALINLIK	AĞIRLIK-kg/m
Şekilli destek sacı DS 01064 34x31,5x43,5x8x6 mm	1.25mm	1.155
	1.55mm	1.410
	2.05mm	1.826
Kutu Destek sacı DS 01064-K 34x29 mm	1.25mm	1.181
	1.55mm	1.443
	2.05mm	1.867

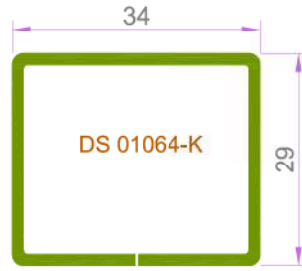
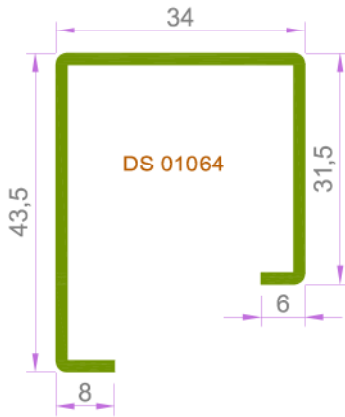
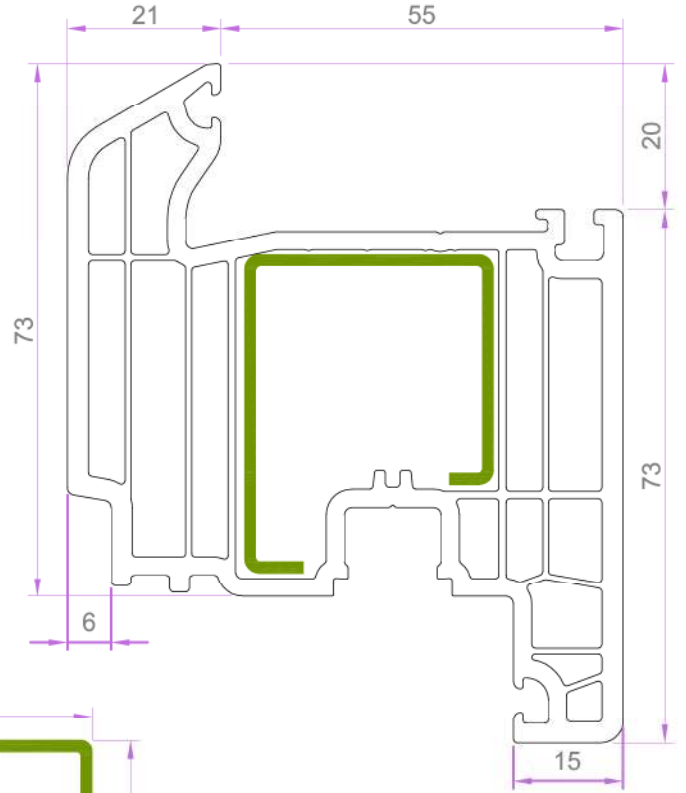

FRANSIZ ADAPTÖR KAPI KANAT

7081	1.486 kg/m
7081 EU-B	1.324 kg/m

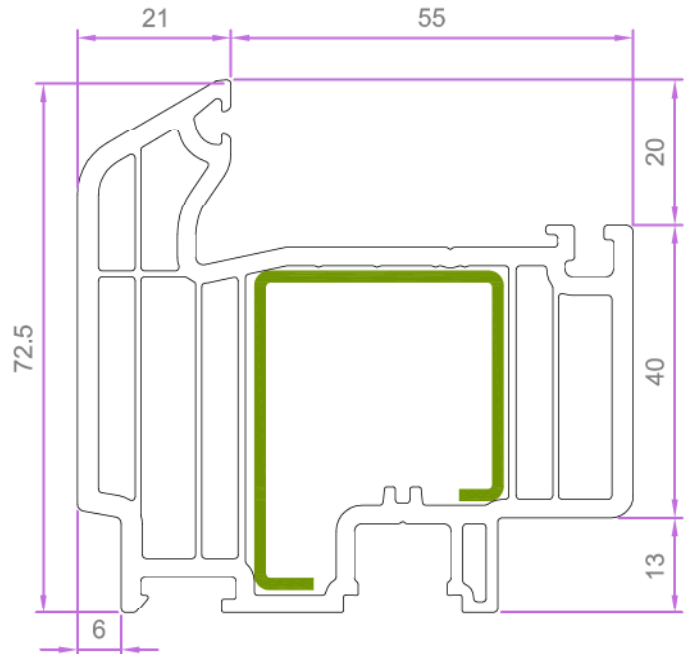

HK01002

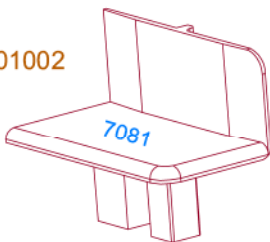

HK01001



HAREKETLİ KANAT İÇ KAPAK

7072 0.326 kg / m

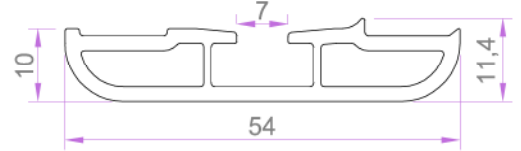

HK01001



ADAPTÖR KANAT DIŞ BİNİ PRF.

7073 0.546 kg / m

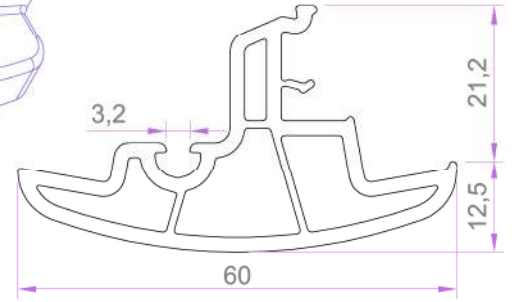

HK01002



HAREKETLİ KANAT İÇ KAPAK

7075 0.184 kg / m

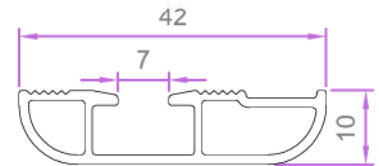

HK01002

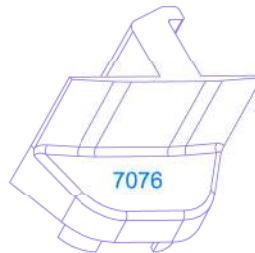

ADAPTÖR KANAT DIŞ BİNİ PRF.

7076 0.292+0.013= 0.305 kg / m

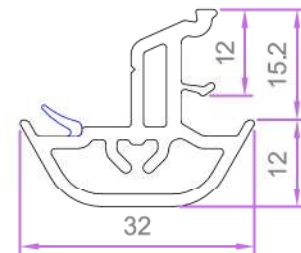

PROFİL TEKNİK ÇİZİMLERİ

TEK CAM ÇİTASI "4mm "

7074

0.355 kg/m

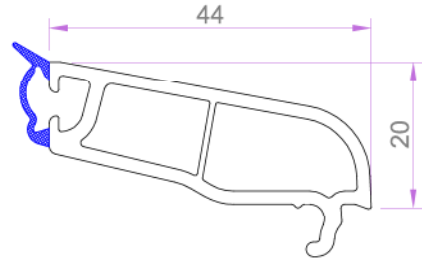

ÇİFT CAM ÇİTASI "24mm "

7062

0.237 kg/m

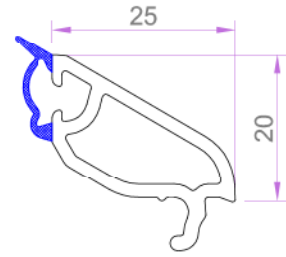

ÇİFT CAM ÇİTASI "28mm "

7064

0.223 kg/m

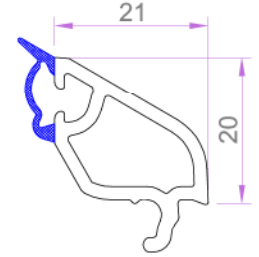

ÜÇLÜ CAM ÇİTASI "34mm "

7063

0.199 kg/m

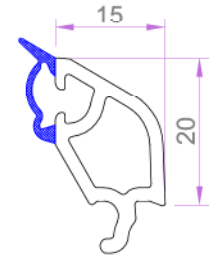

ÜÇLÜ CAM ÇİTASI "40mm "

7464

0.178 kg/m

